



1-512-756-1678

MR5 USER'S MANUAL



The Smallest DVR Module Of The World

Accessories



DVR



Cable



14 pin mini USB Cable



IR Remote control



AV(optional) Cable



AV Cable

Dimension

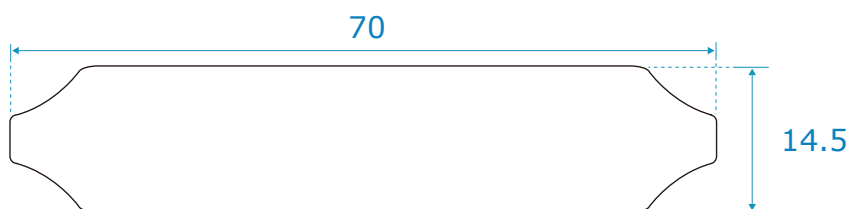

Unit : mm (± 0.5)

MR5 MAIN DEVICE

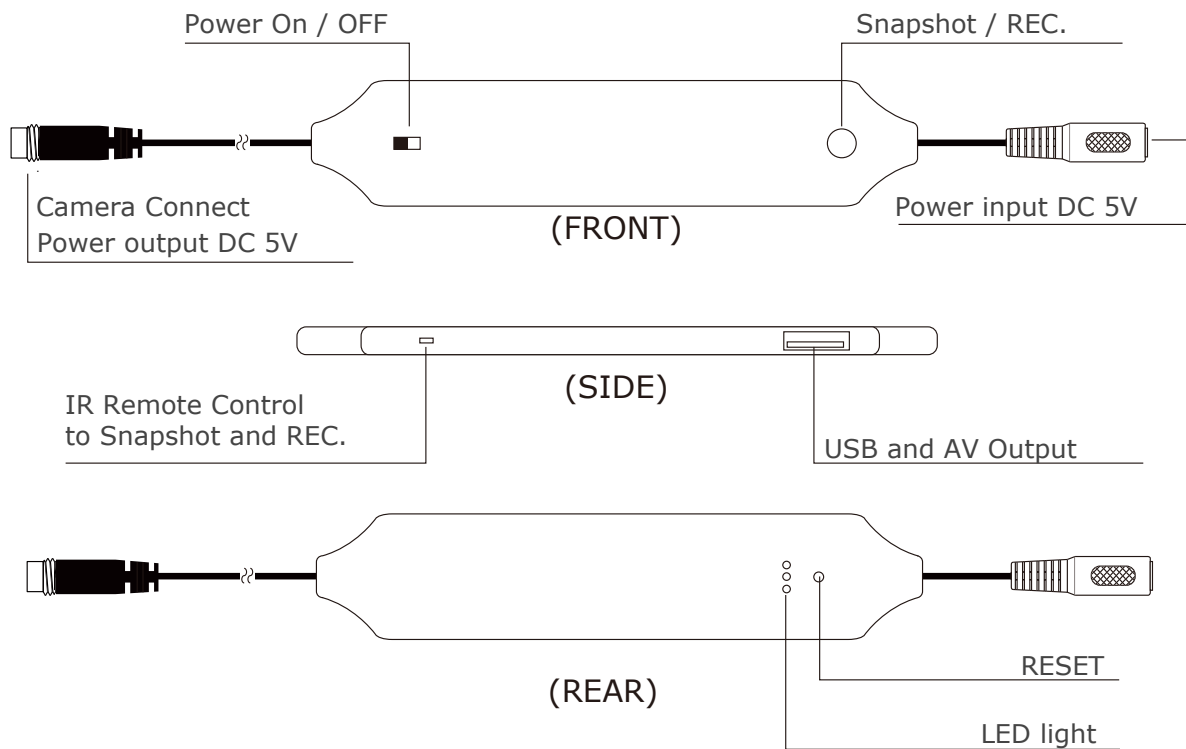

REMOTE CONTROL

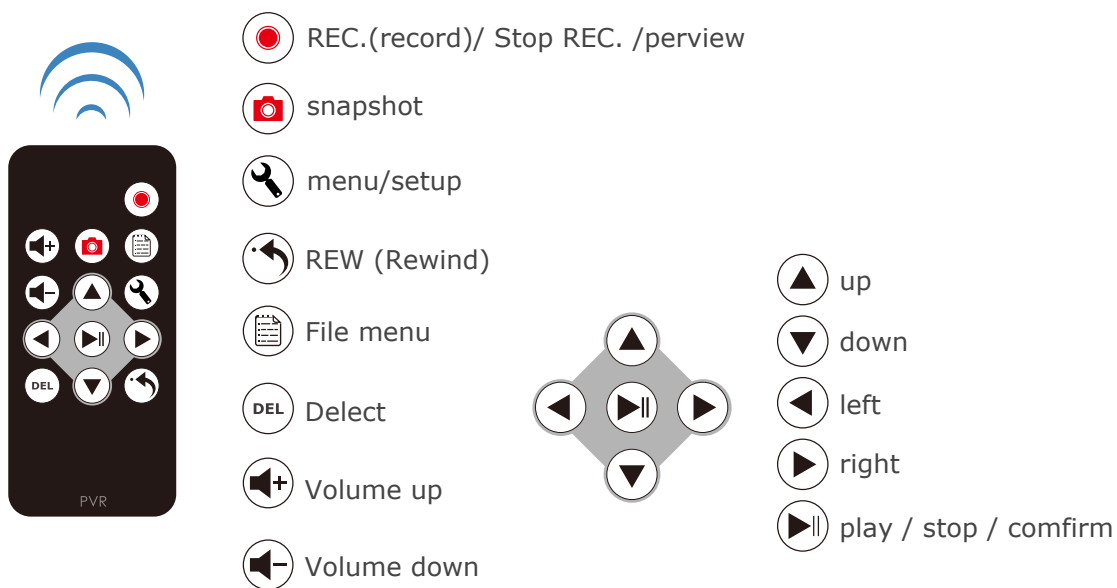

1. Powering ON/ OFF



When recording the screen will display green.

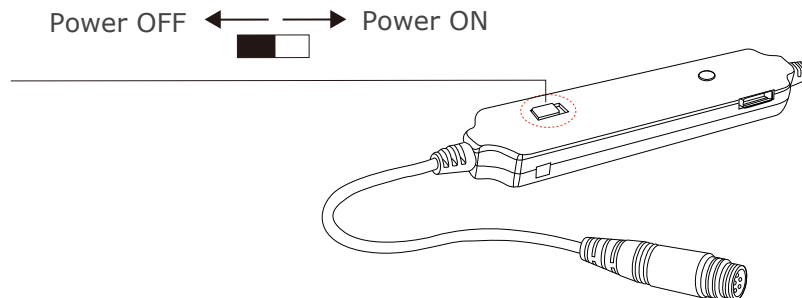

2. REC. & Capture

A. Power on the camera, and LED light (green and orange)

B. REC. : press the (A) button 3 SEC. and LED light on (orange) to start video REC.

Stop REC. : press the (A) button again to stop REC.

C. Snapshot : press the (A) button to capture image (JPG)

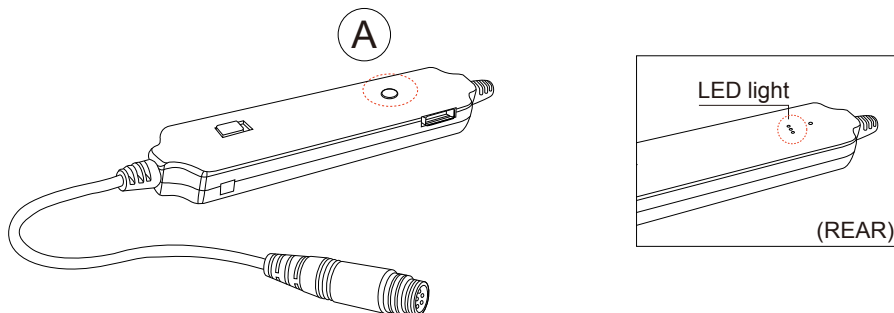

3. IR To Snapshot and REC.

A. Power on the camera, and LED light (green and orange)

B. REC. : press remote control the (red dot) button and the LED will light on (orange) to start video REC.

Stop REC. : press the (red dot) button again to stop REC.

C. Snapshot : press remote control the (red square) button to capture image (JPG)

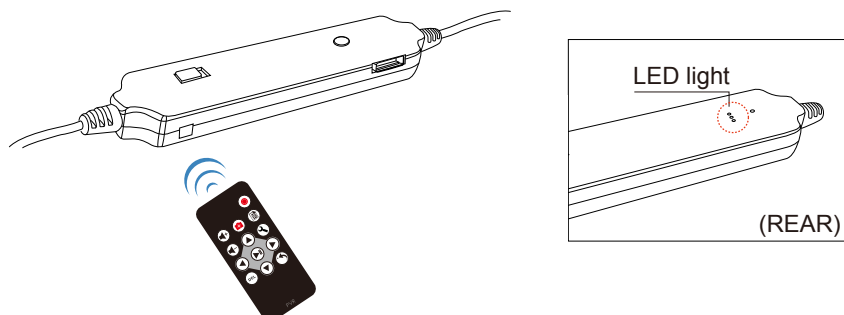

1 Connecting to PC

Window 2000/ XP/ Vista- No Driver Required:

A.Power on the recorder first.

B.Plug the USB (14 Pin MinI USB)cable to the recorder and computer properly

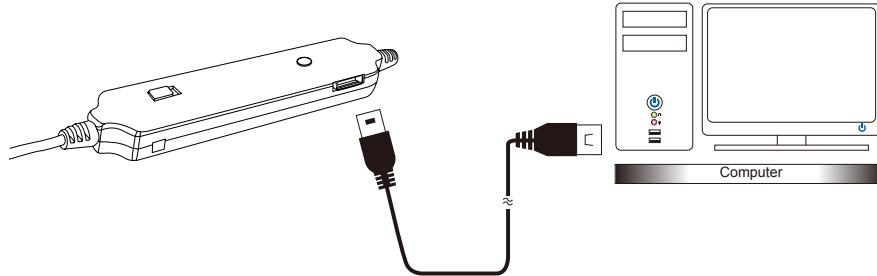

2 Connecting to TV

1.Plug the provided TV cable into the AV port of recorder and connect TV cable to your TV.white to white (audio-out), yellow to yellow (video-out).

2.Turn on the camera and TV. Select "TV output" symbol. You can review the pictures and movies on TV.

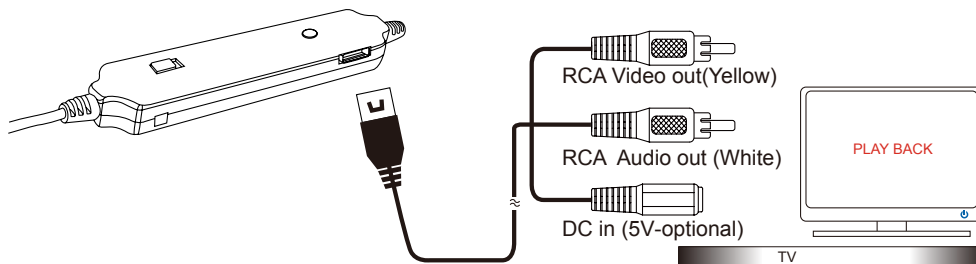

3 .Connecting to Accessory

A. Connect Camera

(OPTIONAL :
HIDDEN CAMERA)

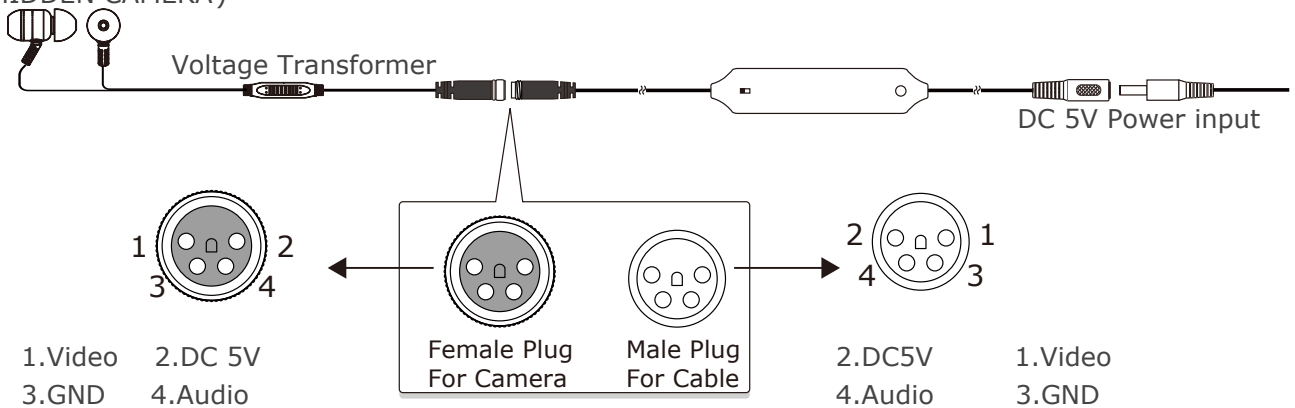

B. Connect Cable

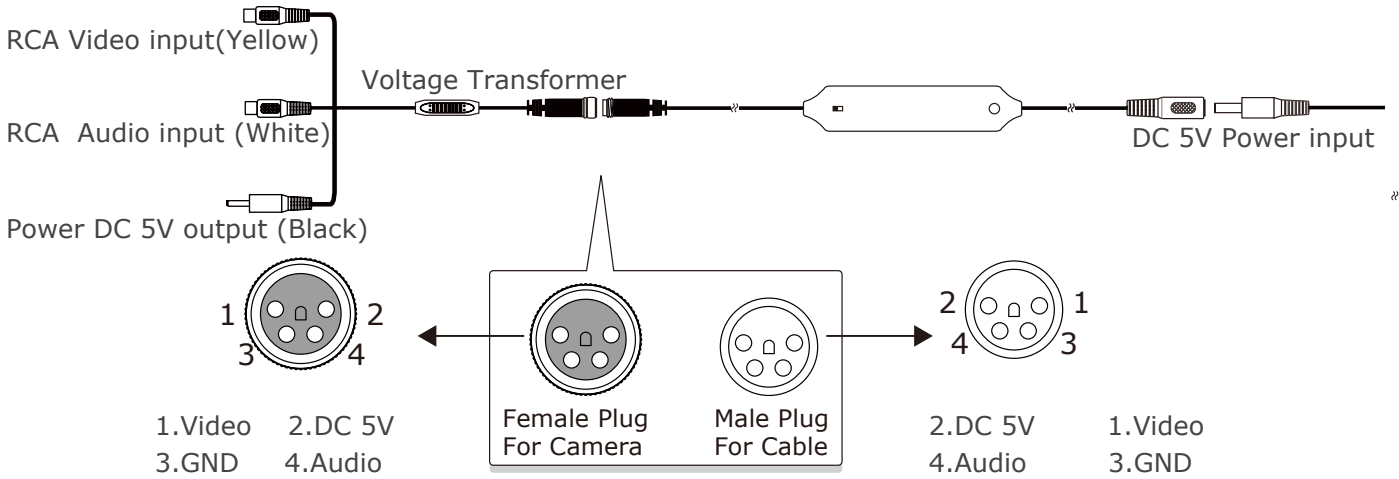

C. Connect Cable(optional-with Voltage Transformer)

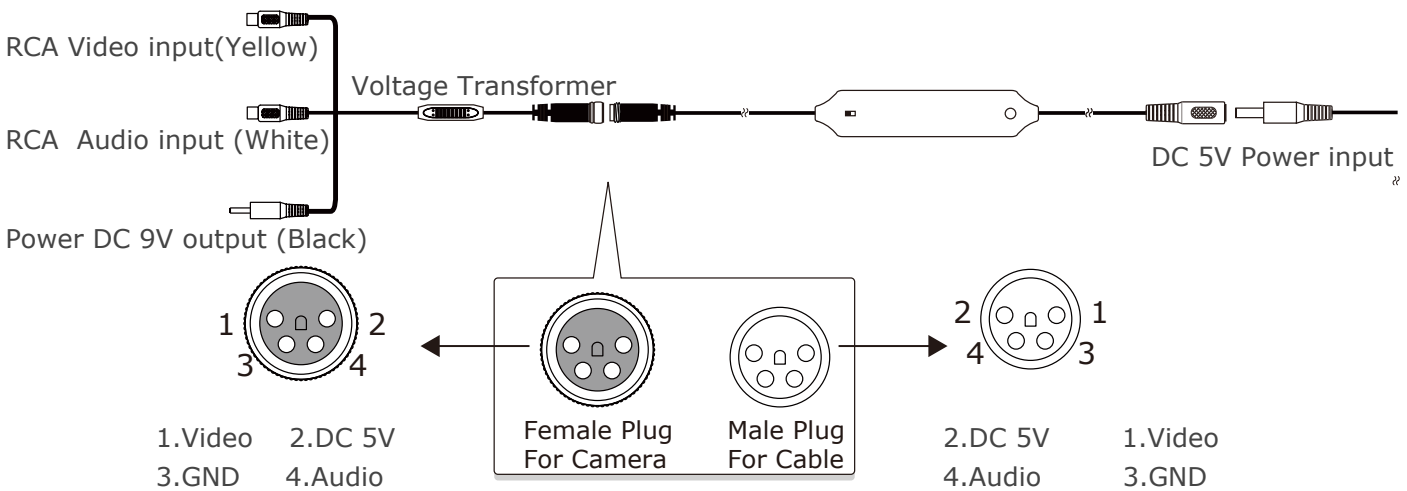

MENU/SETUP

A.MR5 connected with computer or TV

B.Enter menu & setup :Remote control press button into set screen:

- (Press Record or List)
- Date/Time
 - Information on/off
 - PAL/NTSC
 - Format SD
 - Language
 - Audio on/off
 - Loop Record
 - Record Quality

- (Press Record or List)
- Memory
 - Power
 - Firware upgrade
 - Load setting default

Adjust the items used to button , and then press button to enter

Enter item mode used to button , to adjust

REW (Rewind)
Date/Time Year
 Month
 Date
 Hour
 Minute
 second



Information on/off Shows recording time
PAL / NTSC TV type : NTSC or PAL

Format SD
Language English or Chinese
Audio on/off Video recording with or not audio
Loop Record Video recording overwrite on or off

Record Quality Fine , Good , Best
Memory SD memory fress size

Power
Firware upgrade
Load setting default

C.Remote control press button to the next menu or to star to REC.

MENU/SETUP

A.MR5 connected with computer or TV

B.Enter File Menu:Remote control press  button into file menu screen:

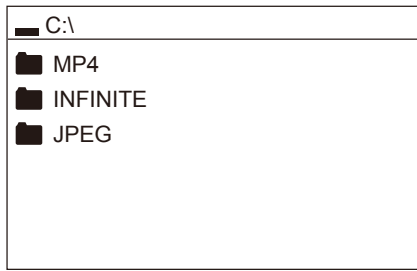

Adjust the items used to button ,  and then press  button to enter





 REW (Rewind)

MP4 Shows recording time

INFINITE..... TV type : NTSC or PAL

JPEG TV type : NTSC or PAL



C.Delete File: After enter the item , adjust the video used to button , and then press ,  to delete

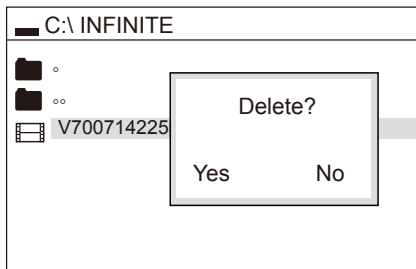

D.Remote control press  button to the next menu or  to star to REC.

Specification

Model	MR5
Video Input	NTSC / PAL
Video Input	1 Channel
Audio Input	1 Channel
Video Output	NTSC / PAL 1 Channel
Audio Output	1 Channel
Video Processing	Chipset DSP Processor
Compression	MPEG4 format
Snapshot	JPG IMAGE 640x480
Control	on board key, IR remote control
Built-in memory	4G
Display Frames	30 FPS 640x480
Recording Frame	30 FPS 640x480
Recording Mode	Normal, Loop, IR remote control
Power Input	DC 5V 300mA
Power Output	DC 5V 300mA
Dimension(mm)	14.5 x 70 (mm)